

2-Wire pH or ORP Transmitter

Operating Instructions

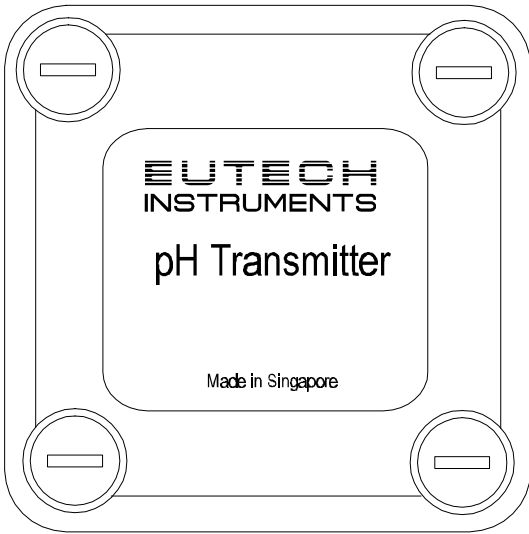

1 Preface

Thank you for purchasing the Eutech pH or ORP Transmitter.

This manual serves to explain the correct installation and operations of the XTR Transmitters. Other Transmitters available individually are: pH, ORP (REDOX), Conductivity, Dissolved Oxygen and Temperature.

- EC-PH-XTR;
- EC-ORP-XTR;
- EC-CON-XTR;
- EC-DO-XTR; and
- EC-TEMP-XTR.

The information presented in this manual is subject to change without prior notice, as improvements are made to the product. While Eutech will endeavor to try its best to inform the market, this does not represent a commitment on the part of Eutech Instruments Pte Ltd.

Eutech Instruments does not accept any responsibility for damage or malfunction of the unit due to improper installation or operation of the Transmitter.

Copyright ©1999 Eutech Instruments Pte Ltd. Version 1.0. All rights reserved.

Eutech Instruments Pte Ltd. Blk 55 Ayer Rajah Crescent #04-14/24, Singapore 139 949. Tel: (65) 778 6876; Fax: (65) 773 0836; e-mail: marketing@eutechinst.com; Home page: <http://www.eutechinst.com>

2 Introduction

The Transmitter is used for the continuous measurement of pH, ORP (REDOX), Conductivity, Dissolved Oxygen or Temperature, in conjunction with an appropriate sensor. Data output is via 4-20 mA current output.

The Transmitter is housed in a IP65 enclosure, with openings for input and 4-20mA output.

3 Diagram and Dimensions (in mm)

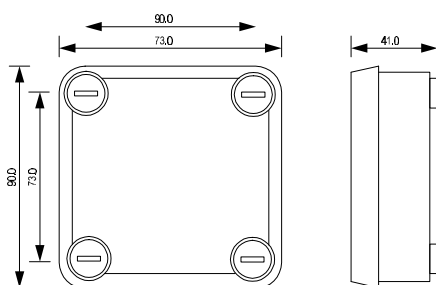

4 Installation

Operating with one or several Transmitters:

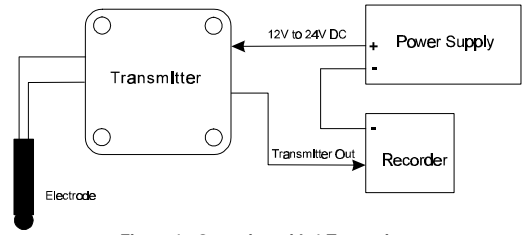

Figure 1 - Operating with 1 Transmitter

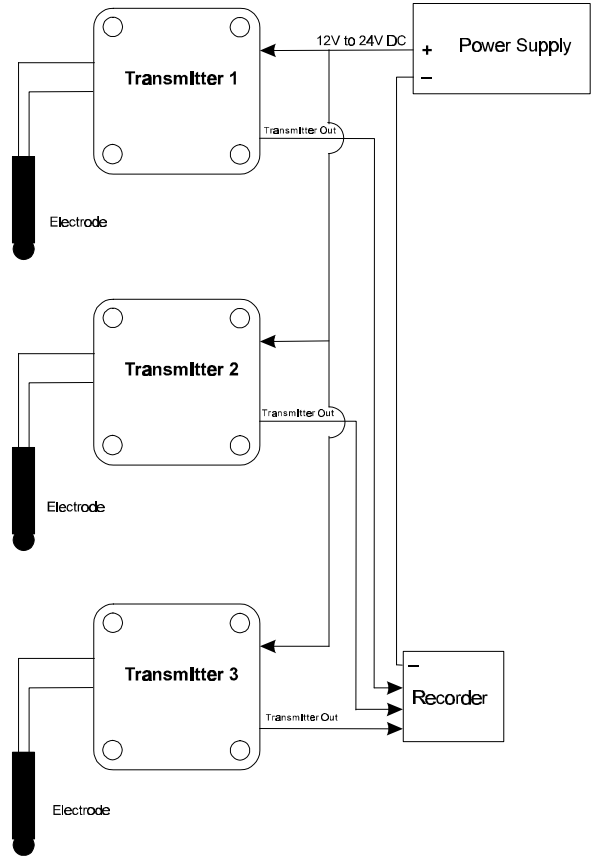
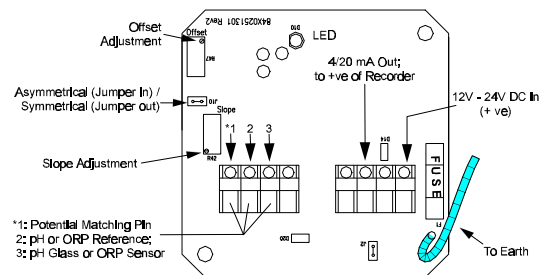

Figure 2 - Operating with several transmitters

5 Electrical Connections



NOTE: In electrically "noisy" environments, select 'Symmetrical' mode of operation and connect a stainless steel rod (Potential Matching Pin - PMP) as shown above. Ensure both the PMP and pH or ORP electrodes are immersed into the solution, even when performing calibration.

6 Before Calibration

Remove cover of Transmitter and ensure that electrode is correctly connected as above. Connect Amp meter to the 4/20mA output of Transmitter (Appendix 1).

7 pH Transmitter Calibration

- 1) Calibrate in pH 7.00 buffer first, and then in either pH 4 or pH 10.
- 2) First, immerse clean pH electrode into a container with fresh pH 7.0 buffer solution;

- 3) Amp meter should read 12mA; if not, calibration is necessary;
- 4) **Locate "Offset adjustment" trimmer;** Using a fine screwdriver, slowly turn trimmer till Amp meter reads 12mA;
- 5) For greater accuracy, adjust slope with pH 4 or 10;
- 6) Rinse probe in de-ionised water and immerse in either pH 4.01 or pH 10.01 buffer solution;
- 7) **In pH 4.01, the output is 8.54mA;**
- 8) **In pH 10.01, the output is 15.44mA;**
- 9) Using a fine screwdriver, slowly turn trimmer, marked 'slope', till Amp meter reads correct mA value with respective buffer solutions.
- 10) Remember to disconnect Amp meter and close cover.

NOTE: For other buffer values, expected current output is based on:

$$mA = \{(16/14) \times \text{buffer pH value}\} + 4mA$$

8 ORP Transmitter Calibration

- 1) Prepare fresh Standard solutions, such as 255mV, 470mV.
- 2) Short ORP inputs and observe Amp meter display;
- 3) Amp meter should read 4mA; if not, calibration is necessary;
- 4) **Locate "Offset adjustment" trimmer;** Using a fine screwdriver, slowly turn trimmer till Amp meter reads 4mA;
- 5) For greater accuracy, adjust the slope with Standard calibrating solutions;
- 6) Rinse probe in de-ionised water and immerse in standard solution;
- 7) **In 255mV solution, the output is 8.08mA;**
- 8) **In 470mV solution, the output is 11.52mA;**
- 9) Using a fine screwdriver, slowly turn trimmer, marked 'slope', till Amp meter reads correct mA value with respective Standard solutions.
- 10) Remember to disconnect Amp meter and close cover.

NOTE: For other Standard values, expected current output is based on:

$$mA = \{(16/1000) \times \text{ORP value of Standard solution}\} + 4mA$$

9 Specifications

Model	ECPHXTR	ECORPXTR
Range	0.00 – 14.00 pH	0 to +1000mV
Accuracy	± 0.05 pH	± 3 mV
Calibration	Offset ±1pH Slope 80 – 120%	Offset ±50mV Slope 80 – 120%
Input	Asymmetrical or Symmetrical (with Potential Matching Pin)	
Output	4-20 mA	
Operating Voltage	DC 12 V to 24 V	
Load	100 Ohms max. for 12 V; 600 Ohms max. for 24V	
Housing	77 x 77 x 28 mm, field mountable	

10 Appendix 1

Connecting Amp Meter for Calibration

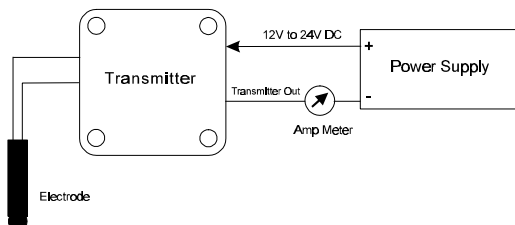

Figure 3 - Method One

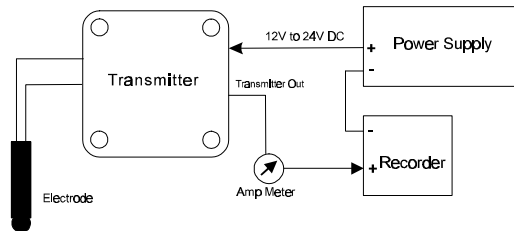

Figure 4 - Method Two

11 Ordering Information

pH

Item	Cat Code
pH Transmitter	ECPHXTR
Combination pH Electrode, General, integral 5m cable	ECARTSO05B
Combination pH Electrode, w/PMP, integral 5m cable	ECARGTSO05B

Dissolved Oxygen

Item	Cat Code
Dissolved Oxygen Transmitter	ECDOXTR
General Purpose D.O. probe, 0.5 – 40 ppm, Industrial, integral 5m cable	ECDODGEN
General Purpose D.O. probe, 0 – 10 ppm, Industrial, integral 5m cable	ECDOTPII

ORP

Item	Cat Code
ORP Transmitter	ECORPXTR
Combination Platinum ORP Electrode, w/PMP, integral 5m cable	ECHPTTTSO05B
Combination Gold ORP Electrode, w/PMP, integral 5m cable	ECHTAUTTSO05B

Conductivity

Item	Cat Code
Conductivity Transmitter	ECCONXTR
2-Pin SS,k=1.0, integral 3m cable	ECCONSEN46

Temperature

Item	Cat Code
Temperature Transmitter	ECTEMPXTR
Pt 100 probe, SS316	ECPT10001M or ECPT10005M

Power Supply

Item	Cat Code
120V Power Supply	EC-120-XTR
220V Power Supply	EC-220-XTR