

Instruction Manual

alpha pH 200

1/8 DIN pH/ORP Controller Transmitter

pH / mV / °C



ISO 9001
CERTIFIED

68X276101 | Rev.4 | Feb 2008

EUTECH
INSTRUMENTS
Technology Made Easy...

PREFACE

This manual serves to explain the use of the alpha pH 200 controller/transmitter. This manual functions in two ways: firstly as a step-by-step guide to help you operate the meter; secondly as a handy reference guide.

This manual is written to cover as many anticipated applications of the alpha pH 200 controller/transmitter as possible. If there are doubts in the use of the alpha pH 200 controller/transmitter, do not hesitate to contact your nearest alpha Authorized Distributor.

The information presented in this manual is subjected to change without notice as improvements are made, and does not represent a commitment on the part of Thermo Scientific.

Thermo Scientific cannot accept any responsibility for damage or malfunction to the unit caused by improper use of the instrument.

Copyright© Sep 2001 All rights reserved.

TABLE OF CONTENTS

1	INTRODUCTION	1
2	SAFETY INFORMATION	2
3	OVERVIEW.....	3
3.1	FRONT PANEL.....	3
3.2	BACK PANEL.....	4
3.3	WIRING	5
3.4	PANEL-MOUNTING THE CONTROLLER	6
4	MEASUREMENT MODE	7
5	PASSWORD.....	8
6	PH CALIBRATION	10
7	ORP CALIBRATION	13
8	TEMPERATURE CALIBRATION.....	14
9	SETUP MODE	15
9.1	GENERAL INFORMATION	15
9.2	SETUP MODE OVERVIEW	16
9.3	SET POINT 1 – P1.0.....	17
9.4	SET POINT 2 – P2.0.....	19
9.5	CONFIGURATION – P3.0	21
9.6	VIEWING CALIBRATION POINTS: PH OR ORP – P4.0.....	23
9.7	VIEWING PH ELECTRODE DATA – P5.0	24
9.8	VIEWING ORP ELECTRODE DATA – P5.0.....	25
9.9	CONTROLLER RESET – P6.0.....	26
10	RELAYS.....	27
11	TRANSMITTER FUNCTION	27
12	ERROR MESSAGES.....	27
13	SPECIFICATIONS.....	28
14	ACCESSORIES.....	29
15	GENERAL INFORMATION.....	34

1 INTRODUCTION

Thank you for purchasing a alpha pH 200 ½ DIN pH/ORP Controller. This controller is part of a series of quality process controllers available from Thermo Scientific/ Eutech Instruments. These sturdy, economical pH/ORP controllers are designed with the features and reliability of a much more expensive instrument.

Your controller includes:

- Removable terminal blocks for easy connections;
- Two mounting brackets for easy panel mounting;

When shipped, the controller is set to the pH mode. See Setup program P3.1 for directions on selecting ORP mode.

Some features of this controller are:

- Two set point, two SPDT relay operation
- Scrolling, 14-segment LED guides user easily through setup functions
- Reliable power supply from 85 to 260 V AC, 50/60 Hz or DC withstands voltage fluctuations
- Push-button operation from the front panel
- Two-point pH calibration, offset temperature and ORP calibration
- Adjustable hysteresis band prevents rapid contact switching near set-point
- Selectable automatic or manual temperature compensation
- Two-level password protection
- Removable terminal strips for quick and easy connections
- Non-Volatile memory retains setup even if power fails, and lets you configure unit before installation
- Isolated 4-20 mA output for remote monitoring or hard copy recording

2 SAFETY INFORMATION

The alpha Controller/Transmitter should be installed and operated only in the manner specified in the Instruction manual. Only skilled, trained or authorized person should carry out installation, setup and operation of the instrument.

Before powering up the unit, make sure that power source it is connected to, is as specified in the top label. Failure to do so may result in a permanent damage to the unit.

The unit has live and exposed parts inside. If it has to be opened, make sure that the power to the unit is off and disconnected.

The unit is Fuse protected. In the event the fuse has to be replaced, use only those as specified in the manual.



The degree of protection against electric shock will be achieved only by observance of the corresponding installation rules.

3 OVERVIEW

3.1 Front Panel

The front panel consists of a 4-digit LED display, 8 LED annunciators and 4 keys.

Annunciators

- | | | |
|----|-------|---|
| 1. | REL 1 | Displayed when Relay 1 is activated |
| 2. | REL 2 | Displayed when Relay 2 is activated |
| 3. | MEAS | Displayed in measurement mode |
| 4. | CAL | Displayed in calibration mode |
| 5. | SETUP | Displayed in setup mode |
| 6. | pH | Unit of the displayed parameter (pH) |
| 7. | °C | Unit of the displayed parameter (temperature) |
| 8. | mV | Unit of the displayed parameter (ORP) |

Keys

- | | | |
|-----|-------------------------------------|--|
| 9. | MODE | Use to toggle between measurement modes (pH/ORP and temperature) |
| 10. | ENTER | Press to confirm changes or to enter into further levels of the lower menu |
| 11. | ▲ / ▼
(increment /
decrement) | Use during calibration and setup modes to increment or decrement . Press both keys together in calibration and setup modes to escape to Measurement mode |
| 12. | Full 14-segment
display | |

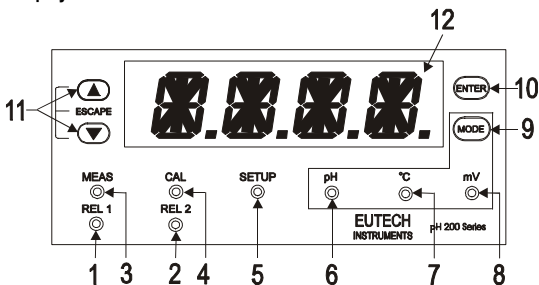

3.2 Back Panel

The back panel consists of four different connectors that can be used with removable terminal blocks (included):

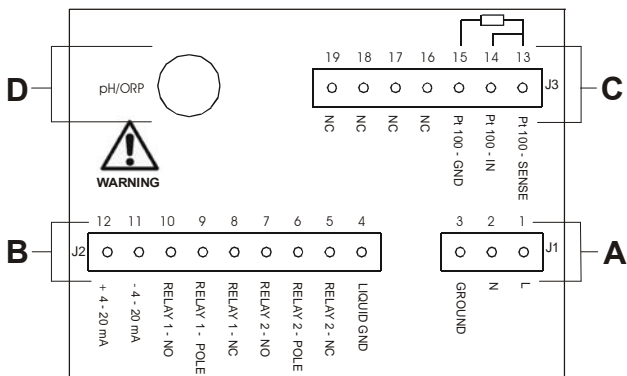

- A. 3 pin connector (for power supply)
- B. 9 pin connector (for relays)
- C. 7 pin connector (for temperature sensor)
- D. BNC connector (for pH or ORP electrode)

A.	1. L- Live 2. N- Neutral 3. E- Earth Ground	C.	13. Pt 100- SENSE 14. Pt 100- IN 15. Pt 100-GND 16. NC 17. NC 18. NC 19. NC
B.	4. Liquid GND 5. RELAY 2- NC 6. RELAY 2- POLE 7. RELAY 2- NO 8. RELAY 1- NC 9. RELAY 1- POLE 10. RELAY 1- NO 11. - 4 to 20 mA 12. +4 to 20 mA	D.	BNC for pH/ORP

3.3 Wiring



Caution: Ensure electrical mains is disconnected before proceeding.

1. Connect the power supply to the three-pin terminal block (D)

- VAC protective ground wire = 3
- VAC neutral wire = 2
- VAC live wire = 1

The alpha pH 200 controller accepts voltages from 85 to 260 VAC, 50/60 Hz or DC.

2. Connect the Pt 100 leads to terminals 13 and 15 (terminal block B). Either wire can be connected to either terminal. Terminals 13 and 14 must be shunted unless using a 3-wire RTD.

NOTE: pH 200 is factory set for manual temperature compensation. ATC can be selected in Program P3.3.

3. Slide the BNC connector of the pH (ORP) probe to the BNC connector on the back of the controller.

Turn the notches of the connector until they lock into place.

4. Power on the controller. The display automatically shows the pH (ORP) reading, and the pH (ORP) annunciator lights.

NOTE: In the event Pt 100 is not connected or the connection is broken in the ATC mode, the pH/ORP display flashes to alert you.

3.4 Panel-mounting the controller

The supplied mounting hardware allows surface mounting to all panels and protective enclosures. Mounting cut-out size is 91 x 45 mm.

To attach the mounting to the controller:

1. Align the catch to the side of the controller, and insert threaded rods through catch.

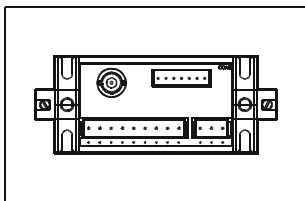

BACK VIEW

2. Screw the threaded-rod through the catch in a clock-wise direction. Tighten until the catch holds the controller firmly against the back of the panel or protective housing. Repeat on the other side.

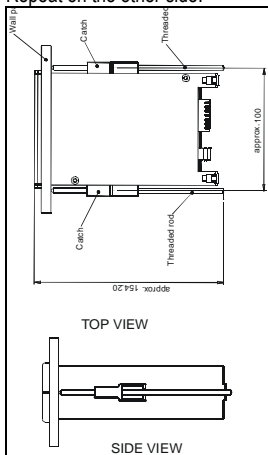

4 MEASUREMENT MODE

Press MODE to toggle between:

- pH (or ORP) measurement mode
- Temperature measurement mode

pH (ORP) measurement mode

The controller starts up in the mode when last powered off (pH or ORP). The appropriate annunciator lights up.

NOTE: Select pH or ORP measurement mode in Setup program P3.1.

Temperature Measurement mode

Press MODE key once to view the temperature measurement. The display shows ATC (Automatic Temperature Compensation) or MTC (Manual Temperature Compensation), then the current measured temperature. The °C annunciator lights when you are measuring temperature.

See Setup program P3.3 for further instructions.

5 PASSWORD

To access Calibration and Setup functions, you need to enter a password code. You cannot change calibration and setup parameters unless you first enter the password.

The alpha pH 200 controller features two separate passwords:

- pH (ORP) calibration mode password = 011
- Setup program password = 022

To enter the password:

1. Press ENTER twice. The display reads "P.000". The first "0" flashes.
2. Press ENTER again to leave the first digit "0" and to scroll to the next number.
3. Press the ▲ and ▼ keys to change the second digit to the correct number (1 or 2). Press ENTER.
4. Press the ▲ and ▼ keys to change the third digit to the correct number (1 or 2). Press ENTER. The whole display will now flash to prompt for its confirmation.

If you enter an incorrect digit, press MODE to back up.

5. Press ENTER again to confirm your password. You are now in Calibration mode or Setup mode, depending on password entered.

P.WRD

P.000

P.000

P.010

P.020

P.011

P.022

P.011

P.022

6 PH CALIBRATION

The alpha pH 200 controller features seven preset buffer values (pH 1.68, 4.01, 6.86, 7.00, 9.18, 10.01, 12.45) for quick auto-calibration at one or two points. **The first calibration point must be pH 6.86 or 7.00.** When you calibrate this instrument, you need to use FRESH standard pH buffer solution that matches these values.

NOTE: If you are in ORP mode, see Program 3.0 for instructions on switching to pH mode.

1. Key in the password "011" using the method described in Section 5.
2. The display scrolls BUFF and either pH 7.00 or 6.86. You must calibrate at one of these two buffers for the first calibration. Use ▲ / ▼ keys to select pH 7.00 or 6.86.
3. Make sure the electrode is in the buffer solution. In ATC mode, you must also immerse the temperature sensor in the buffer solution. In the symmetrically high-resistance measurement mode, you must also immerse the solution ground (potential equalization pin) in the buffer.
4. Allow the electrode time to stabilize.
5. Press ENTER. The instrument will blink with the uncalibrated pH value corresponding to the mV output of your pH probe.
6. Press ENTER to confirm the buffer value. The display blinks the calibrated value twice, shows "DONE" and moves to the next buffer.

NOTE: Buffer must be within ± 1.5 pH of the value you are calibrating to or Err1 will display. To clear the Err1 display and return to calibration mode, press ▲ / ▼ keys together.



Err 1

NOTE: If the ATC mode has been selected and the Pt 100 is not connected or if it is broken, the pH display will flash. Under this condition, the calibration will not be allowed.

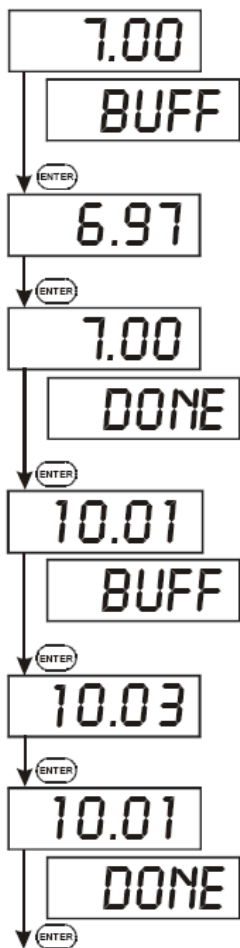

If you are performing 1-point calibration, press ▲/▼ keys together to return to measurement mode. If you are performing two-point calibration, proceed with the next step.

7. Use ▲/▼ keys to select the next buffer value (pH 1.68, 4.01, 9.18, 10.01 and 12.45).
8. Make sure the electrode is in the correct buffer solution. Allow the electrode time to stabilize.
9. Press ENTER. The instrument blinks with the uncalibrated pH value corresponding to the mV output of your pH probe.
10. Press ENTER to confirm the buffer value. The display blinks the calibrated value twice and flashes "DONE". Press the ENTER again to return to measurement mode.

NOTE: Buffer must be within ± 1.0 pH of the value you are calibrating to, or Err1 will display. To clear the Err1 display and return to calibration mode, press ▲/▼ keys together.

Notes:

You can view the pH calibration points in the Setup program. See Setup program P5.0.

The slope and offset are re-determined after each calibration.

If the value displayed in steps 5 and 9 differ substantially from the buffer value, this indicates electrode drift. Consider replacing your electrode.

7 ORP CALIBRATION

mV (ORP) values may be offset at up to ± 150 mV to agree with a calibration solution or an established work standard.

1. Key in the password "011" as per procedure described in Section 5.
2. Controller will blink with uncalibrated mV output of your electrode.
3. Determine the mV value of your solution with an accurate meter (such as the pH 6).
4. Press the ▲ or ▼ keys to offset the mV value on the controller display to match the value of the solution you are measuring.
5. Press ENTER. The display flashes "DONE". Press ENTER again to return to measurement mode.

NOTE: You can view the mV offset in the Setup program, P5.0.

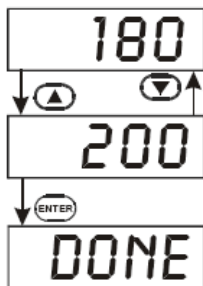

8 TEMPERATURE CALIBRATION

This controller features selectable Automatic Temperature Compensation (ATC) or Manual Temperature Compensation (MTC).

ATC: ATC mode requires a Pt 100 temperature element. ATC automatically compensates for temperature fluctuations. You can offset your ATC temperature reading by $\pm 10^{\circ}\text{C}$.

Important: If there is no temperature element wired to the controller and ATC is selected on, the screen will flash in pH or ORP mode, and you will see an error message (OR) in temperature mode.

MTC: MTC lets you select a specific value at which temperature will be compensated. You can select a manual temperature value from $- 10$ to 110°C . Factory default is 25.0°C .

See Setup program P3.3 for instructions on ATC or MTC selection.

To offset temperature:

1. Press MODE to select $^{\circ}\text{C}$ mode. The display shows MTC or ATC, then the temperature.
2. Key in the password "011" as per procedure in Section 5.
3. The screen will flash the current $^{\circ}\text{C}$ reading.
4. For ATC: Determine the temperature of your solution with an accurate meter (such as the Temp 5). Press the \blacktriangle or \blacktriangledown keys to offset the $^{\circ}\text{C}$ value on the controller display to match the value of the solution you are measuring.
For MTC: Press the \blacktriangle or \blacktriangledown keys to offset the $^{\circ}\text{C}$ value on the controller display to match the desired value.
5. Press ENTER. The display flashes "DONE". Press ENTER again to return to measurement mode.

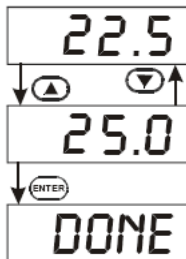

9 SETUP MODE

9.1 General Information

IMPORTANT: When Setup mode is entered, the controller automatically goes into a "HOLD" mode where the 4-20 mA output freezes and the relays are de-activated (if it was in an activated condition). Upon return to the measurement mode, both the 4-20mA output and relay activities resume, depending on the settings.

To enter setup mode:

1. Key in the password "022" using the method described in section 5.
2. Press the ▲ or ▼ keys to display the various sub-menus shown here.
3. When a sub-menu item is displayed, press the ENTER key to enter that sub-menu.
4. Press ▲ and ▼ keys together (ESCAPE) to leave the Setup mode and return to Measurement mode.

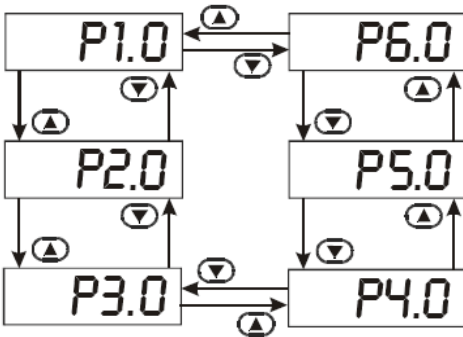

9.2 Setup mode overview

P1.0: Set Point 1

- P1.1: select relay 1 set point value
- P1.2: select relay 1 as low or high set point
- P1.3: set relay 1 hysteresis value

P2.0: Set Point 2

- P2.1: select relay 2 set point value
- P2.2: select relay 2 as low or high set point
- P2.3: set relay 2 hysteresis value

P3.0: Configuration

- P3.1: select pH or ORP units
- P3.2: select symmetrical or asymmetrical input mode
- P3.3: select temperature compensation (MTC or ATC)

P4.0: Calibration data

- P4.1: view first calibration point
- P4.2: view second calibration point (pH mode only)

P5.0: Electrode data

- P5.1: view electrode offset
- P5.2: view electrode slope (pH mode only)
- P5.3: view temperature probe offset (ATC mode only)

P6.0 Controller reset

- P6.1: clear calibration data and revert to factory default settings

9.3 Set Point 1 – P1.0

Setup program P1.0 allows you to set parameters for relay 1.

P1.1: select relay 1 set point value

P1.2: select relay 1 as low or high set point

P1.3: set relay 1 hysteresis value (dead band)

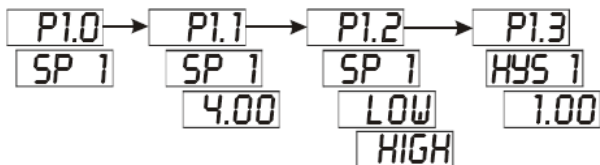

Press ▲ and ▼ keys together (ESCAPE) at anytime, to leave the Setup mode and return to Measurement mode.

P1.1: Select relay set point value

This lets you choose the pH (or ORP) value that will cause your controller to activate. If this value is crossed, the set point relay 1 LED will light.

1. Key in the password "022" as per procedure in Section 5.
2. The screen will scroll P1.0 and SP1. Press ENTER.
3. The screen will scroll P1.1, SP1, then the current set point value.
4. Press ▲ or ▼ keys and adjust first relay set point. You can adjust it in 0.01 increments from 0.00 to 14.00 pH (-999 to 1000 mV).
5. Press ENTER to confirm and continue to step three of P1.2.

P1.2: Set relay as high or low set point

Select a low set point to activate controller when your value undershoots the set point; select a high set point to activate controller when your value overshoots the set point.

Using both SP1 and SP2, you can select lo/lo, lo/hi, hi/lo or hi/hi set points.

1. Key in the password "022" as per procedure in Section 5.
2. The screen will scroll P1.0 and SP1. Press ENTER twice.
3. The screen will scroll P1.2, SP1, and LOW (or HIGH).
4. Press the ▲ or ▼ keys to toggle between LOW and HIGH.
5. Press ENTER to confirm and continue to step 3 of P1.3.

P1.3: Set Hysteresis value

Hysteresis prevents rapid contact switching if your value is fluctuating near the set point. Once activated, the relay will not return to resting position until the measured value has passed through the set point plus hysteresis value.

Example: With a low set point of 4.00 and a hysteresis value of 0.5, the relay will activate at pH values below 4.00, but will not de-activate till the measured pH value rises above pH 4.50.

The hysteresis window can be set to any value within the range shown below:

- pH mode: 0.00 to 2.00 pH
 - ORP mode: 0 to 300 mV
1. Key in the password "022" as per procedure in Section 5.
 2. The screen will scroll P1.0 and SP1. Press ENTER three times.
 3. The screen will scroll P1.3, HYS1, and current hysteresis value.
 4. Press the ▲ or ▼ keys to adjust the hysteresis value.
 5. Press ENTER to confirm and return to general Setup mode.
Press ▲ and ▼ keys together (ESCAPE) to return to measurement mode.

9.4 Set Point 2 – P2.0

Setup program P2.0 allows you to set parameters for relay 2.

P2.1: select relay 2 set point value

P2.2: select relay 2 as low or high set point

P2.3: set relay 2 hysteresis value (dead band)

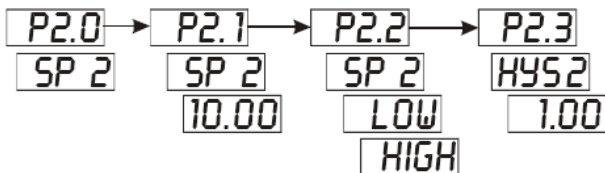

Press ▲ and ▼ keys together (ESCAPE) at anytime, to leave the Setup mode and return to Measurement mode.

P2.1: Select relay set point value

This lets you choose the pH (or ORP) value that will cause your controller to activate. If this value is crossed, the set point relay 2 LED will light.

1. Key in the password "022" as per procedure in Section 5.
2. Press ▲ key once. The screen will scroll P2.0 and SP2. Press ENTER.
3. The screen will scroll P2.1, SP2, then the current set point value.
4. Press ▲ or ▼ keys and adjust second relay set point. You can adjust it in 0.01 increments from 0.00 to 14.00 pH (-999 to 1000 mV).
5. Press ENTER to confirm and continue to step three of P2.2.

P2.2: Set relay as high or low set point

Select a low set point to activate controller when your value undershoots the set point; select a high set point to activate controller when your value overshoots the set point.

Using both SP1 and SP2, you can select lo/lo, lo/hi, hi/lo or hi/hi set points.

1. Key in the password "022" as per procedure in Section 5.
2. Press ▲ key once. The screen will scroll P2.0 and SP2. Press ENTER twice.
3. The screen will scroll P2.2, SP2, and LOW (or HIGH).
4. Press the ▲ or ▼ keys to toggle between LOW and HIGH.
5. Press ENTER to confirm and continue to step 3 of P2.3.

P2.3: Set Hysteresis value

Hysteresis prevents rapid contact switching if your value is fluctuating near the set point. Once activated, the relay will not return to resting position until the measured value has passed through the set point plus hysteresis value.

Example: With a high set point of 10.00 and a hysteresis value of 0.5, the relay will activate at pH values above 10.00, but will not de-activate till the measured pH value decreases below pH 9.50.

The hysteresis window can be set to any value within the range shown below:

- pH mode: 0.00 to 2.00 pH
 - ORP mode: 0 to 300 mV
1. Key in the password "022" as per procedure in Section 5.
 2. Press ▲ key once. The screen will scroll P2.0 and SP2. Press ENTER three times.
 3. The screen will scroll P2.3, HYS2, and current hysteresis value.
 4. Press the ▲ or ▼ keys to adjust the hysteresis value.
 5. Press ENTER to confirm and return to general Setup mode.
Press ▲ and ▼ keys together (ESCAPE) to return to measurement mode.

9.5 Configuration – P3.0

Setup program P3.0 let you configure controller parameters.

P3.1: select pH or ORP mode of operation

P3.2: select symmetrical or asymmetrical input mode

P3.3: select temperature compensation (manual or automatic)

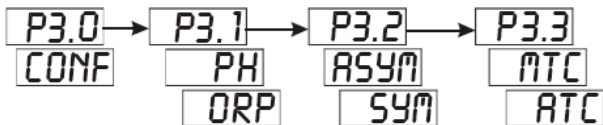

Press ▲ and ▼ keys together (ESCAPE) at anytime, to leave the Setup mode and return to Measurement mode.

P3.1: Select pH or ORP

This lets you set the controller to take pH or ORP measurements.

1. Key in the password "022" as per procedure in Section 5.
2. Press ▲ key twice. The screen will scroll P3.0 and CONF. Press ENTER.
3. The screen will scroll P3.1 and PH (or ORP).
4. Press ▲ or ▼ keys to toggle between pH and ORP.
5. Press ENTER to confirm and continue to step three of P3.2.

P3.2 Select symmetrical or asymmetrical input mode

Use asymmetrical mode under normal operating conditions. Use symmetrical mode when the measuring environment is electrically noisy (i.e. in electroplating environments). Default is asymmetrical.

See Appendix 1 for more details on operation in symmetrical and asymmetrical modes.

1. Key in the password "022" as per procedure in Section 5.
2. Press ▲ key twice. The screen will scroll P3.0 and CONF. Press ENTER twice.
3. The screen will scroll P3.2 and ASYM (or SYM).
4. Press ▲ or ▼ keys to toggle between ASYM and SYM.
5. Press ENTER to confirm and continue to step three of P3.3.

NOTE: If the unit is set to symmetrical mode, the potential matching pin (or liquid ground) has to be connected to pin 4 (connector C). Please refer to the Back Panel diagram on page 4.

P3.3: Select temperature compensation

This controller features selectable automatic temperature compensation (ATC) or manual temperature compensation (MTC). ATC automatically compensates for temperature fluctuations; MTC let you select a specific value at which temperature will be compensated. ATC readings require a temperature sensor.

1. Key in the password "022" as per procedure in Section 5.
2. Press ▲ key twice. The screen will scroll P3.0 and CONF. Press ENTER three times.
3. The screen will scroll P3.3 and MTC (or ATC).
4. Press ▲ or ▼ keys to toggle between MTC and ATC.
5. Press ENTER to confirm and return to general Setup mode.
Press ▲ and ▼ keys together (ESCAPE) to return to measurement mode.

NOTE: ORP is not affected by temperature and so ATC does not operate in ORP mode. When set for ATC, the pH 200 will display temperature if a 100 Ω Pt 100 sensor is connected.

9.6 Viewing Calibration points: pH or ORP – P4.0

Setup program P4.0 lets you view the current points at which the controller is calibrated. This is a “view only” parameter.

P4.1: first calibration point

P4.2: second calibration point (pH only)

When controller has no calibration points in memory, the display will show “-----”.

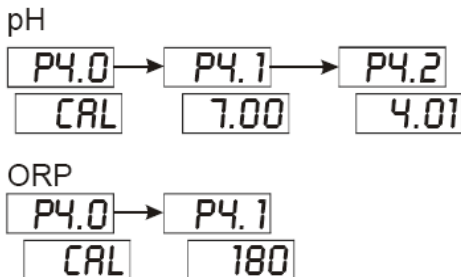

Press ▲ and ▼ keys together (ESCAPE) at anytime, to leave the Setup mode and return to Measurement mode.

P4.0: Viewing calibration points

1. Key in the password “022” as per procedure in Section 5.
2. Press ▲ key three times. The screen will scroll P4.0 and CAL. Press ENTER.
3. The screen will scroll P4.1, then CAL, then the first calibration point.
4. Press ENTER.
In pH mode. The screen will display P4.2, then CAL, then the second calibration point.
In ORP mode, the screen returns to the general Setup menu.
5. If you are in pH mode, press ENTER again to confirm and return to general Setup mode.
Press ▲ and ▼ keys together (ESCAPE) to return to measurement mode.

9.7 Viewing pH Electrode Data – P5.0

In pH mode, Program 5 has three “view only” options that lets you check the electrode parameters for diagnostic purposes.

P5.1: view pH electrode offset

P5.2: view pH electrode slope

P5.3: view temperature probe offset (ATC on only)

These parameters will change each time you recalibrate the controller:

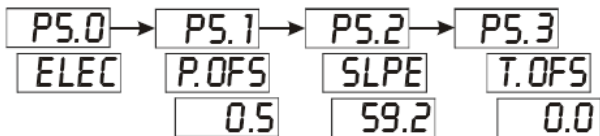

Press ▲ and ▼ keys together (ESCAPE) at anytime, to leave the Setup mode and return to Measurement mode.

P5.0: Viewing pH electrode data

1. Key in the password “022” as per procedure in Section 5.
2. Press ▲ key four times. The screen will scroll P5.0 and ELEC. Press ENTER.
3. The screen will scroll P5.1, then P.OFS, then pH electrode offset in mV at the pH 6.86 / 7.00 calibration point.
4. Press ENTER. The screen will display P5.2, then SLPE, then the electrode slope in mV.
5. MTC on: press ENTER to return to general Setup mode.
ATC on: go to next step.
6. The screen will scroll P5.3, then T.OFS, then the temperature offset value.
7. Press ENTER to return to general Setup mode.
Press ▲ and ▼ keys together (ESCAPE) to return to measurement mode.

9.8 Viewing ORP Electrode Data – P5.0

In ORP mode, Program 5 has two “view only” options that lets you check the electrode parameters for diagnostic purposes.

P5.1: view ORP electrode offset

P5.2: view temperature probe offset (ATC on only)

These parameters will change each time you recalibrate the controller:

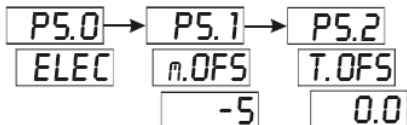

Press ▲ and ▼ keys together (ESCAPE) at anytime, to leave the Setup mode and return to Measurement mode.

P5.0: Viewing ORP electrode data

1. Key in the password “022” as per procedure in Section 5.
2. Press ▲ key four times. The screen will scroll P5.0 and ELEC. Press ENTER.
3. The screen will scroll P5.1, then m.OFS, then the ORP electrode offset at the point of calibration.
4. MTC on: press ENTER to return to general Setup mode.
ATC on: go to next step.
5. The screen will scroll P5.2, then T.OFS, then the temperature offset value.
6. Press ENTER to return to general Setup mode.
Press ▲ and ▼ keys together (ESCAPE) to return to measurement mode.

9.9 Controller Reset – P6.0

This parameter lets you reset the controller. All pH and ORP calibration data will be cleared, and all Setup parameters revert to factory default values. Temperature mode (ATC or MTC) and calibration data remains unchanged.



Press ▲ and ▼ keys together (ESCAPE) at anytime, to leave the Setup mode and return to Measurement mode.

P6.0: Controller reset

1. Key in the password "022" as per procedure in Section 5.
2. Press ▲ key five times. The screen will scroll P6.0 and RST. Press ENTER.
3. The screen will scroll P6.1, then NO.
4. Press ▲ or ▼ keys to toggle between YES and NO. Pressing YES will clear all calibration data and setup parameters!
5. Press ENTER to confirm selection and return to general Setup mode.
Press ▲ and ▼ keys together (ESCAPE) to return to measurement mode.

10 RELAYS

The alpha pH 200 features two SPDT non-powered relays; rated for 6A at 110 VAC, 250 VAC maximum. When your process exceeds the set parameters of a relay set point, the REL 1 or REL 2 indicator lights up.

To set parameters for relay one and relay two, see Setup programs P1.0 and P2.0.

11 TRANSMITTER FUNCTION

If remote data logging is required, a 4-20 mA current loop can be connected. The current will be proportional to the pH (or ORP) displayed on the panel display.

pH: 0.00 pH – 4 mA; 14.00 pH = 20 mA
ORP: -999 mV = 4 mA; 1000 mV = 20 mA

The 4-20 mA current loop can drive a load resistance of no more than 200 Ω .

12 ERROR MESSAGES

The following table provides a guideline to enable diagnosis of possible problems indicated by the messages generated by the meter.

Error Message	Indicates	Possible Cause	Corrective Action
Err1	Calibration Error	Incorrect buffer solution used or contamination of buffer solution resulting to calibration being attempted outside the allowable calibration window	Check if right buffer solution was selected or use fresh buffer solution.
Err2	Wrong keypad input	When an invalid key is pressed in a selected mode.	Select valid operations depending on the selected mode.

13 SPECIFICATIONS

pH Range	0.00 to 14.00 pH
Resolution/Accuracy	0.01 / ± 0.01 pH
mV Range	-999 to 1000 mV
Resolution/Accuracy	1 / ± 2 mV
Temperature	-10 to 110 °C
Resolution/Accuracy	0.1 / ± 0.5 °C
Sensor	Pt 100 (3-wire)
Temperature Compensation	Automatic / Manual (0 to 100 °C)
<i>Set-point And Controller Functions</i>	
Function	Limit Control
Switching pH/ORP Hysteresis	0.00 to 2.00 pH / 0 to 300 mV
Contact Outputs, Controller	2 SPDT relays
Switching Voltage / Current / Power	Max 250 VAC / Max 3A / Max 600 VA
<i>Electrical Data And Connections</i>	
Power Requirements	85 to 260 VAC, 50/60 Hz or DC
Signal Output / Load	4-20 mA galvanically isolated / 200 Ω
pH / ORP Input	BNC (10 ¹² Impedance)
Connection Terminals	3 Detachable connectors (3-pin; 7-pin & 9-pin terminal blocks)
Main Fuse	500 mA, slow-blow
<i>Environmental Conditions</i>	
Ambient Temp. Operating Range	- 10 to 50 °C (14 to 122 °F)
Rel. Humidity	10 to 95 % (non-condensing)
<i>Mechanical Specifications</i>	
Ingress Protection	IP50
Dimensions (Control Panel Housing – W x H x D)	96 x 48 x 150 mm
Weight	300g (350g boxed)

14 ACCESSORIES

Product Description	Code no.
pH Combination Electrode with Pt 100 RTD and PMP	EC-100GTSO-05B
pH Combination Electrode with HF resistant glass (w/o ATC & PMP)	EC-ARTSOHF-05B
pH Combination Electrode with PMP (w/o ATC)	EC-ARGTSO-05B
pH Combination Electrode with high temperature (110 °C) and high pressure resistance (9 bar) (w/o ATC & PMP)	EC-ARHTTSO-05B
pH Combination Electrode (w/o ATC & PMP)	EC-ARTSO-05B
ORP Gold Electrode with PMP but w/o ATC	EC-HTAUTSO-05B
ORP Platinum Electrode with PMP but w/o ATC	EC-HTPTTSO-05B

Note: Above pH/ORP electrodes withstand up to 6 bar pressure except EC-ARHTTSO-05B (up to 9 bar). These electrodes have integral 5m measuring cable terminating with a BNC connector.

Please contact your authorised distributor or dealer for the prices of extension measuring cables and other accessories like tee joints, electrode assembly, and calibration solutions.

Appendix 1: Asymmetrical / Symmetrical Mode

The alpha pH 200 controller can be operated in the asymmetrical or symmetrical modes (See Set up Program P3.2).

Asymmetrical mode:

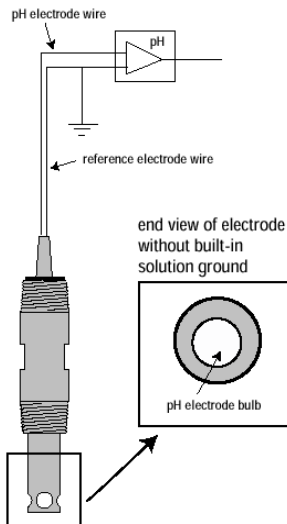

Asymmetrical mode works well in environments where there is little or no electrical noise. When there is noise, the noise acts as a common signal, which is picked up by both the pH and the reference electrodes.

However, since the reference electrode is grounded to the ground potential of the amplifier, electrical noise will be present only on the pH electrode. This noise is amplified along with the pH signal, which causes fluctuations in the pH or ORP readings.

Electrical noise from a DC source (as in an electroplating tank) will typically result in stable but incorrect values.

Symmetrical mode:

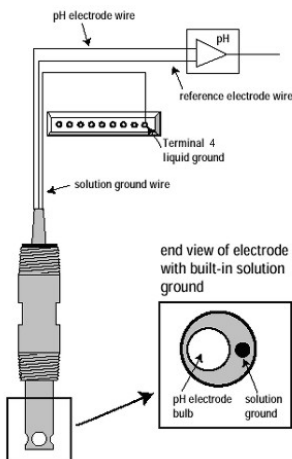

For noisy electrical environments, the alpha pH 200 controller offers Symmetrical Mode operation. To take advantage of Symmetrical operation, you must have an electrode with a solution ground (potential matching) pin, such as the EC-ARGTSO-05B or EC-100GTSO-05B.

If your electrode does not have a solution ground, be sure to set the controller to Asymmetrical mode.

Symmetrical mode avoids grounding the reference electrode by reconfiguring the input to a floating differential mode. The electrical noise appears equally on the pH and reference electrodes, and is therefore rejected by the operational amplifier.

Appendix 2: Simple Explanation on the Function of Hysteresis

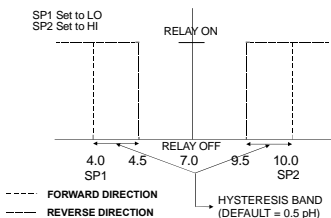

The controller relay activates when the set-point is reached. In the reverse direction, it does not deactivate when the value reaches the set-point. Instead, it continues to be active till the value reaches the amount set by the Hysteresis band.

Appendix 3: Factory Defaults

Resetting the controller to factory default settings (See program P6.0) clears all calibration data and most other setup functions.

The following settings will remain unchanged:

1. Measurement mode (pH or ORP)
2. Temperature compensation mode (ATC or MTC)
3. Temperature offset calibration value, if in ATC mode.

<i>pH Defaults</i>	
pH input	Asymmetrical
offset	0.0 mV
slope	59.2 mV
Set point 1	pH 4.00 / LOW / Hysteresis pH 1.00
Set point 2	pH 10.00 / HIGH / Hysteresis pH 1.00
<i>mV Defaults</i>	
mV input	Asymmetrical
offset	0.00 mV
Set point 1	- 100 mV / LOW / Hysteresis 5 mV
Set point 2	900 mV / HIGH / Hysteresis 5 mV
<i>Temperature Defaults</i>	
Temp. Compensation mode	remains unchanged
MTC mode	reset to 25°C if in MTC mode
ATC mode	remains at last calibration if in ATC mode

Appendix 4: External Relays

The relays on the alpha pH 200 series controller are rated for 6 amps at 110 VAC and can be wired directly to your final control element (provided its power requirements does not exceed this). However, to preserve the life of your controller, or if higher power is needed, it is recommended that you use the controller relay to drive an external relay.

Diagram below shows a typical installation. Wiring should be changed appropriately if normally closed (N.C.) operation is desired.

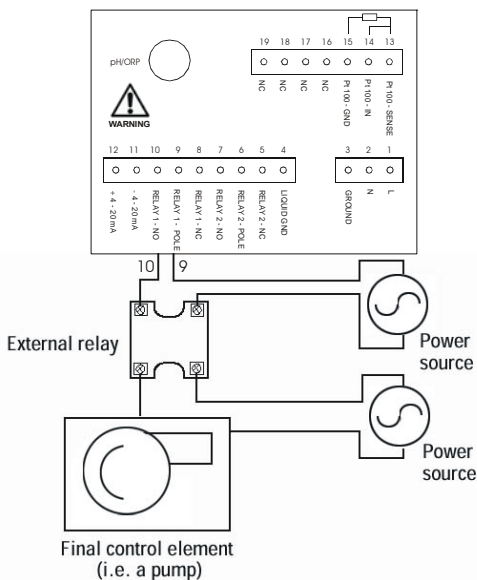

15 GENERAL INFORMATION

Warranty

Thermo Scientific warrants this product to be free from significant deviations in material and workmanship for a period of one year from the date of purchase. If repair is necessary and has not been the result of abuse or misuse within the warranty period, please return by freight pre-paid and amendment will be made without any charge. Thermo Scientific's Customer Service Dept. will determine if product problem is due to deviations or customer abuse. Out of warranty products will be repaired on a charge basis.

Return of Goods

Authorisation must be obtained from the Customer Service Dept. to issue a RGA (Return of Goods Authorisation) number before returning items for any reason. When applying for authorisation, please include data requiring the reason of return. Items must be carefully packed to prevent damage in shipment and insured against possible damage or loss. Thermo Scientific will not be responsible for any damage resulting from careless or insufficient packing.

Warning: Shipping damage as a result of inadequate packaging is the user/distributor's responsibility, whoever applicable. Please follow the guidelines below before shipment.

Guidelines for Returning Unit for Repair

Use the original packaging material, if possible when shipping the unit for repair. Otherwise wrap it with bubble pack and use a corrugated box for better protection. Include a brief description of any faults suspected for the convenience of Customer Service Dept., if possible.

For more information on Thermo Scientific products, contact your nearest distributor or visit our website listed below:

<p>Thermo Scientific Water Analysis Environmental Instruments Blk 55, Ayer Rajah Crescent, #04-16/24 Singapore 139949 Tel: (65) 6778 6876 Fax: (65) 6773 0836 E-mail: eutech@thermofisher.com Web-site: http://www.thermo.com/process</p>	<p>Oakton Instruments P.O Box 5136, Vernon Hills, IL 60061, USA Tel (in U.S.): 888-462-5866 Tel (outside U.S.): 1-847-549-7600 Fax: (1) 847-247-2984 E-mail: info@4oakton.com Web-site: http://www.4oakton.com</p>
<p>Distributed by:</p>	

